



# Applicazione del QbD nello sviluppo di un ciclo di liofilizzazione per prodotti farmaceutici



**Roberto Pisano, PhD**  
**Irene Oddone, PhD**

*Politecnico di Torino*  
*Department of Applied Science and Technology*

**6 May 2016, MILAN**



# The freeze drying process

Freeze-drying is a process where water (or another solvent) is removed from a frozen solution by sublimation.

The process consists of three steps:

- Freezing
- Primary drying
- Secondary drying

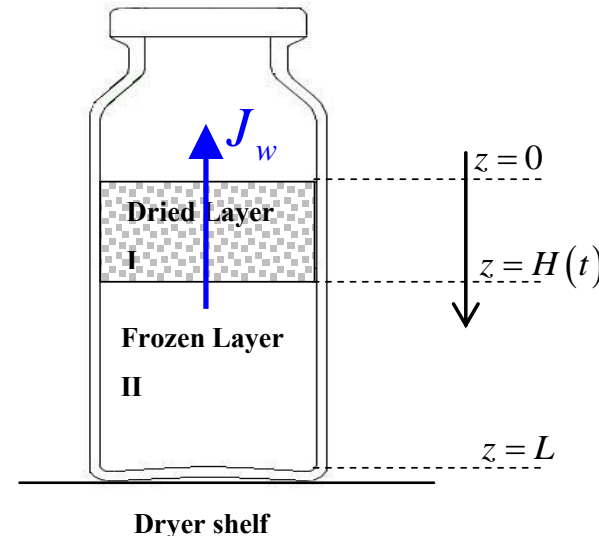

The process is suitable for those products that can be damaged by drying processes at higher temperatures.

The freeze-dried products can be stored for long time and can be easily reconstituted.



# The freeze drying process

During the operation, product temperature has to be maintained below a maximum value, in order to avoid the collapse of the cake structure (or melting).



Besides, the sublimation flux has to be maintained below a limit value corresponding to the occurrence of sonic flow in the duct connecting the drying chamber to the condenser.

Thermocouple for temperature measurement →



# Modelling and Process Efficiency

A pharmaceutical company usually spend many years bringing a new drug to market. Therefore, the launch of new products as soon as clinical trials are completed would be beneficial. The design of the manufacturing plant, while trials are still going on, is crucial to success.

The **lyophilisation** process is known to be time consuming and expensive and is often **the rate-limiting process**.

In order to make the lyophilisation process more efficient, formulations and **drying conditions should be optimised**. At this purpose, models can give a valuable contribution.

Theoretical models can predict the behavior of a system under a set of conditions and this information is useful to guide the design of a cycle.



# General modelling principles

## How to choose the best model?

You cannot choose the best model, because there is not one, but you can choose a useful model.

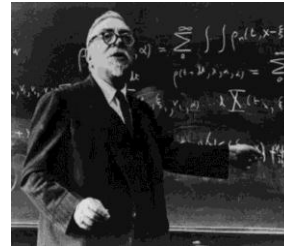

*The best material model of a cat is another, or preferably the same, cat.*

**Norbert Wiener**

## How to make a useful model?

The level of detail depends on the final use and on the existing knowledge of the process.

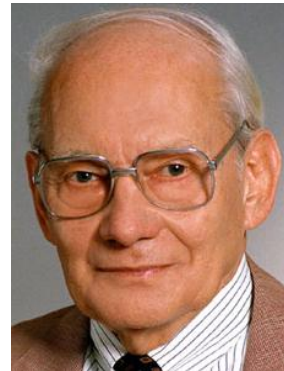

*A theory has only the alternative of being right or wrong. A model has a third possibility: it may be right, but irrelevant.*

**Manfred Eigen**

# General modelling principles

## How to choose the best model?

You cannot choose the best model, because there is not one, but you can choose a useful model.

## How to make a useful model?

The level of detail depends on the final use and on the existing knowledge of the process.

Approximate mechanisms to a satisfactory degree.

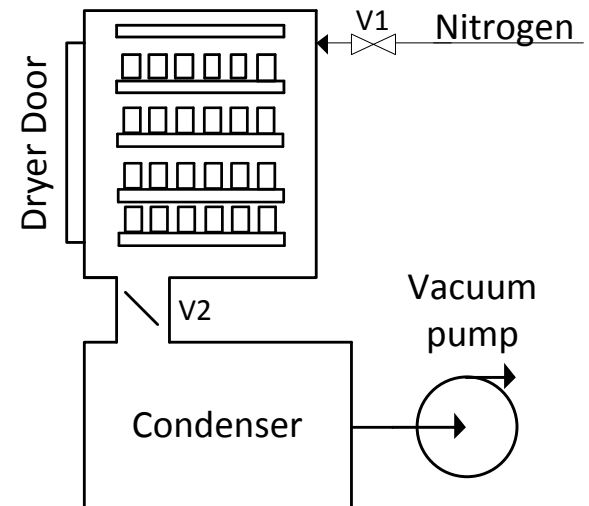
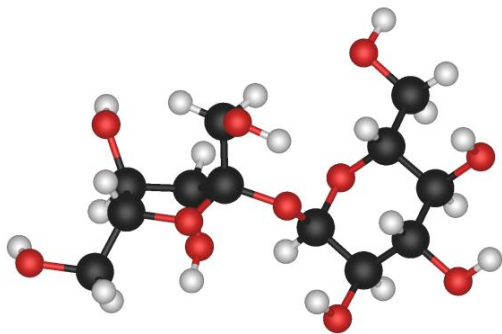

# General modelling principles

## ICH-Endorsed Guide for ICH Q8/Q9/Q10 Implementation

The level of oversight should be commensurate with the level of risk associated with the use of the specific model. An important factor to consider is the model contribution in assuring the quality of the product.

**Low-Impact Models** which are used to support product and/or process development.

**Medium-Impact Models** which can be used to insure that the quality of the product is respected, but are not the sole indicators of product quality.

**High-Impact Models** which predictions are a significant indicator of the final quality of the product.

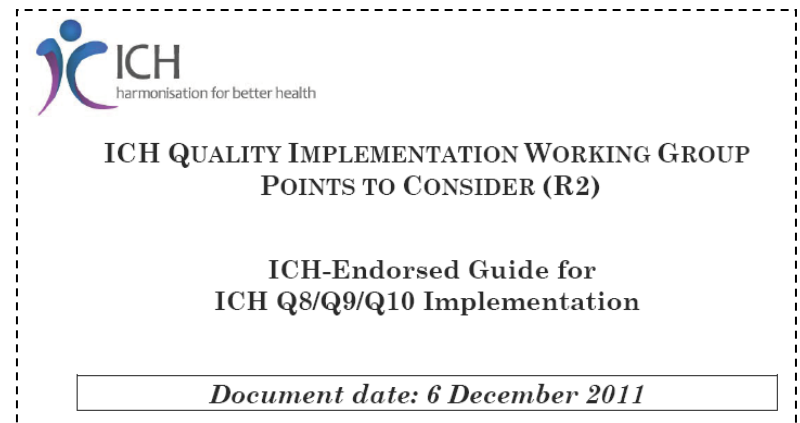

# The rationale for freeze-drying modelling



In freeze-drying, models can be used to ...

- Improve understanding of the process,
- Train plant operators,
- Find the optimal design of the equipment,
- Support process troubleshooting,
- Develop a cycle,
- Transfer and scale up a cycle from laboratory to industrial apparatus.



# Modelling & Cycle development



During cycle development, scientists aim to find a combination of temperature, pressure, and time that satisfies specific product quality attributes.

The optimal combination is typically found through an extended experimental campaign based on trial and error.

Mathematical modelling allows scientists to make better decisions during experimentation, enhance scientific understanding and predict the behaviour of a process under a set of conditions. Models are thus an effective tool to obtain product **quality by design** and also to **reduce processing cost**.

# Modelling & Cycle development



Various process variables affect the efficiency of the freeze-drying process.

The temperature of the product is one of these key variables because ...

- Ice sublimation is faster at higher temperature,
- Drying at temperatures above the collapse temperature produces product damage.



Several models have been proposed to describe the product dynamics but, as they have the same practical implications, we should **choose the simplest one**.

# Off-line methods for cycle development

Off-line methods use mathematical modeling to know in advance which conditions fail to achieve the target.

## Design Space

The design space is a multi-dimensional map showing the combination of processing conditions (temperature of the heat transfer fluid, pressure, and drying progress) and process parameters which provide assurance of quality (critical temperature of the product to be dried).

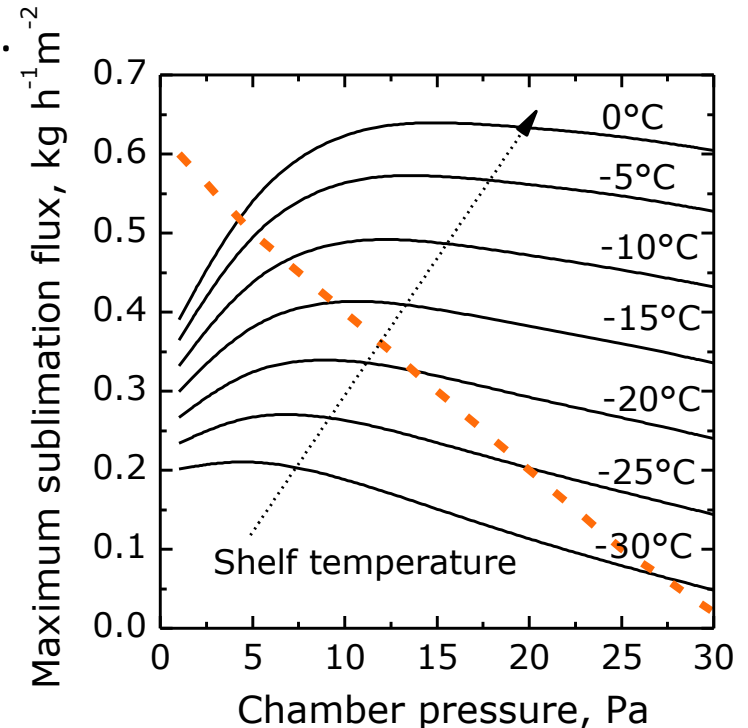
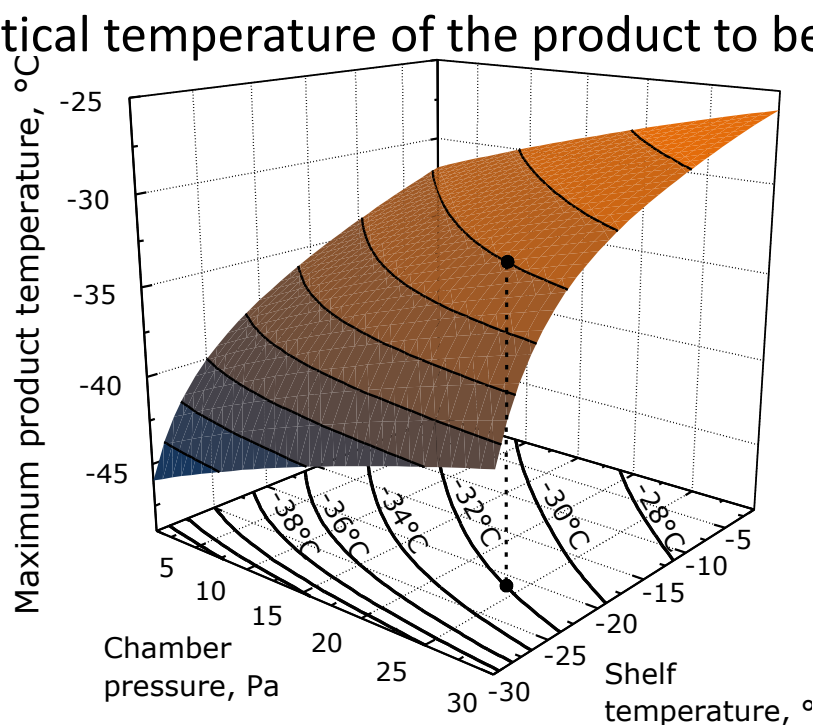

# Unidirectional model for primary drying

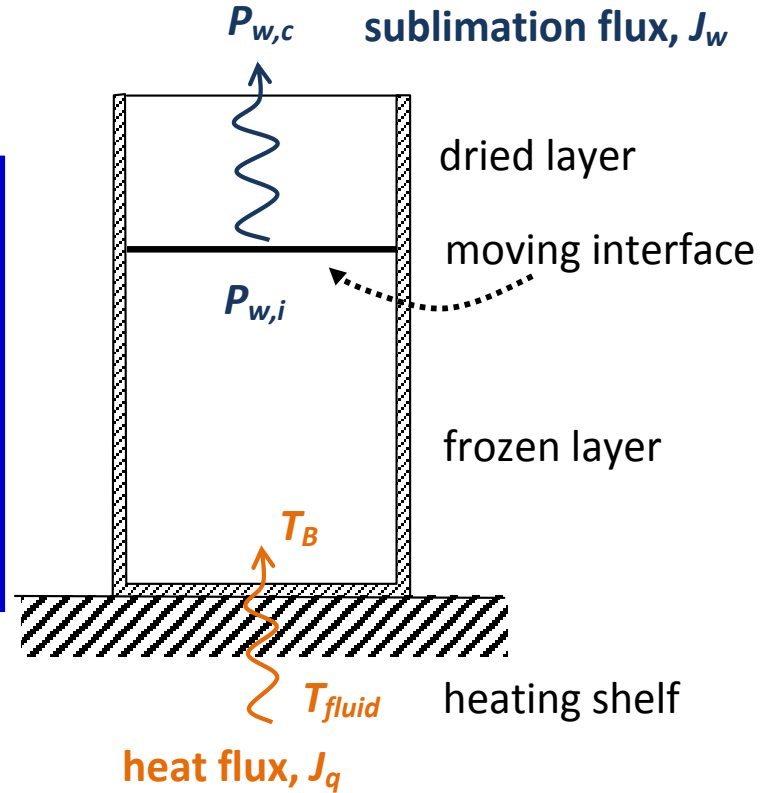
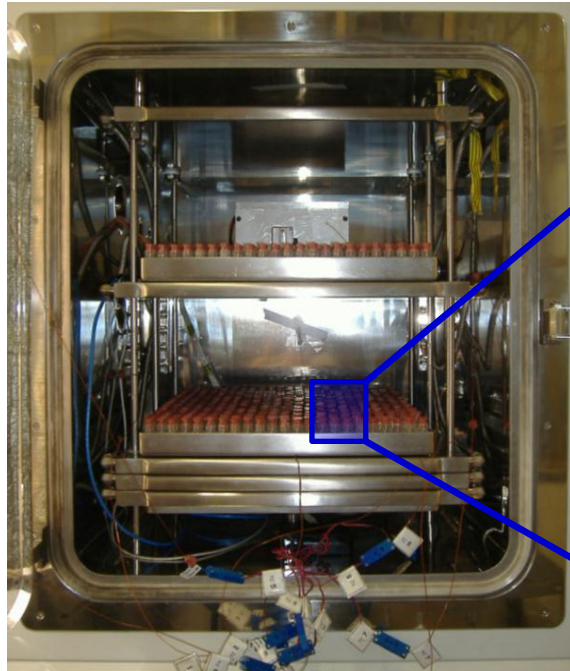

## Mass transfer

$$J_w = \frac{1}{R_p} (P_{w,i} - P_{w,c})$$

## Heat transfer

$$J_q = K_v (T_{fluid} - T_B)$$

# Determination of model parameters

## The heat transfer coefficient ( $K_v$ )

An effective coefficient can be used to account for all the mechanisms involved in the heat transfer between the product and the heating shelf.

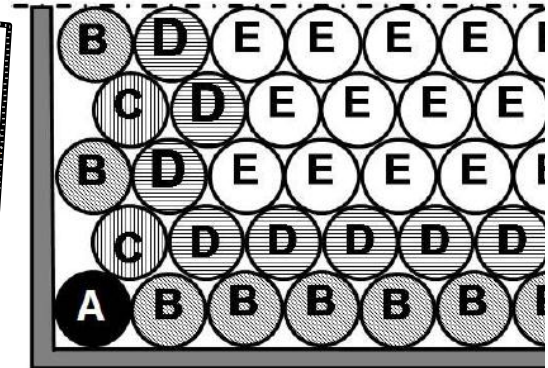
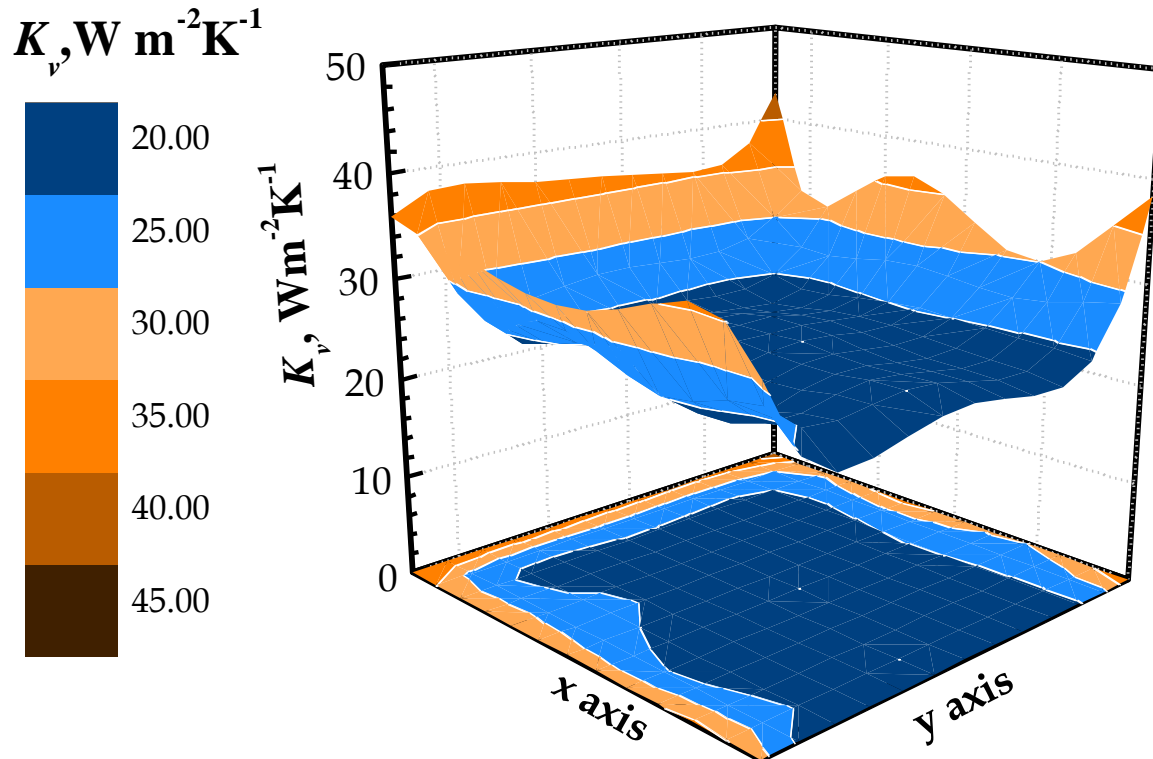

$$K_v = \frac{\Delta m \cdot \Delta H_s}{A_v \cdot \int_0^{\Delta t} (T_{\text{fluid}} - T_B) dt}$$

Distribution of the heat transfer coefficient within a batch of vials as measured by the gravimetric procedure

# Determination of model parameters

## The mass transfer resistance ( $R_p$ )

A microbalance can be used to monitor the evolution of mass and, thus, of vapour flow rate for 15 vials. For the same vials, the temperature of the product is monitored through thermocouples. The  $R_p$  value was then calculated as:

$$R_p = \frac{P_{ice}(T_i) - P_{w,c}}{J_w}$$

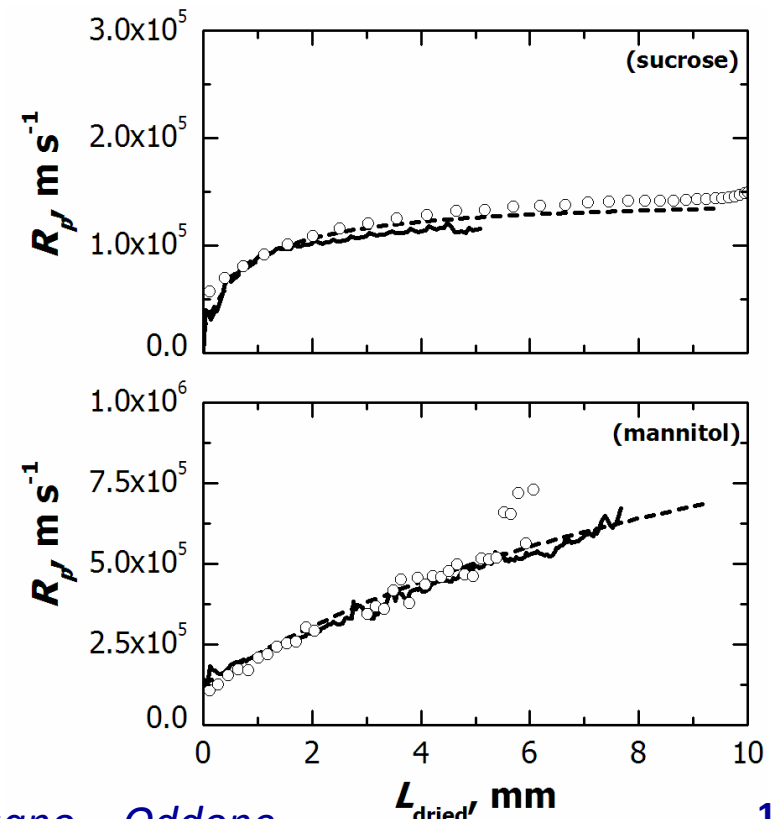
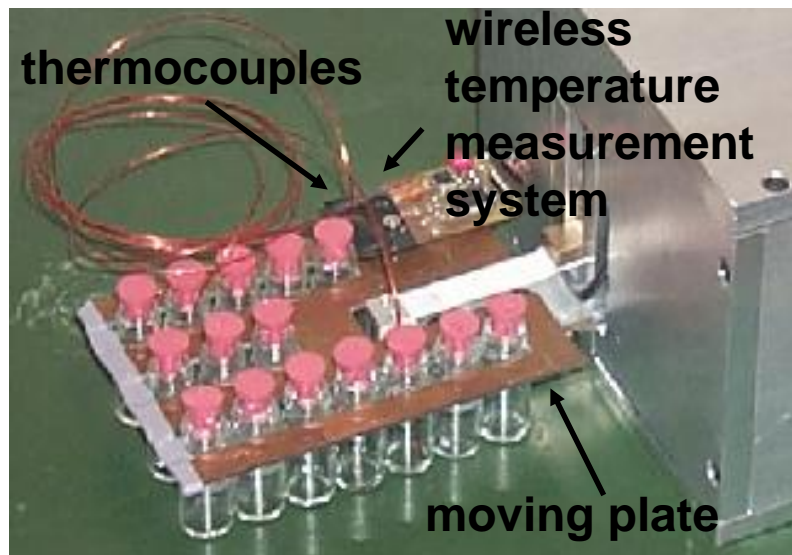

# $R_p$ is influenced by the freezing step

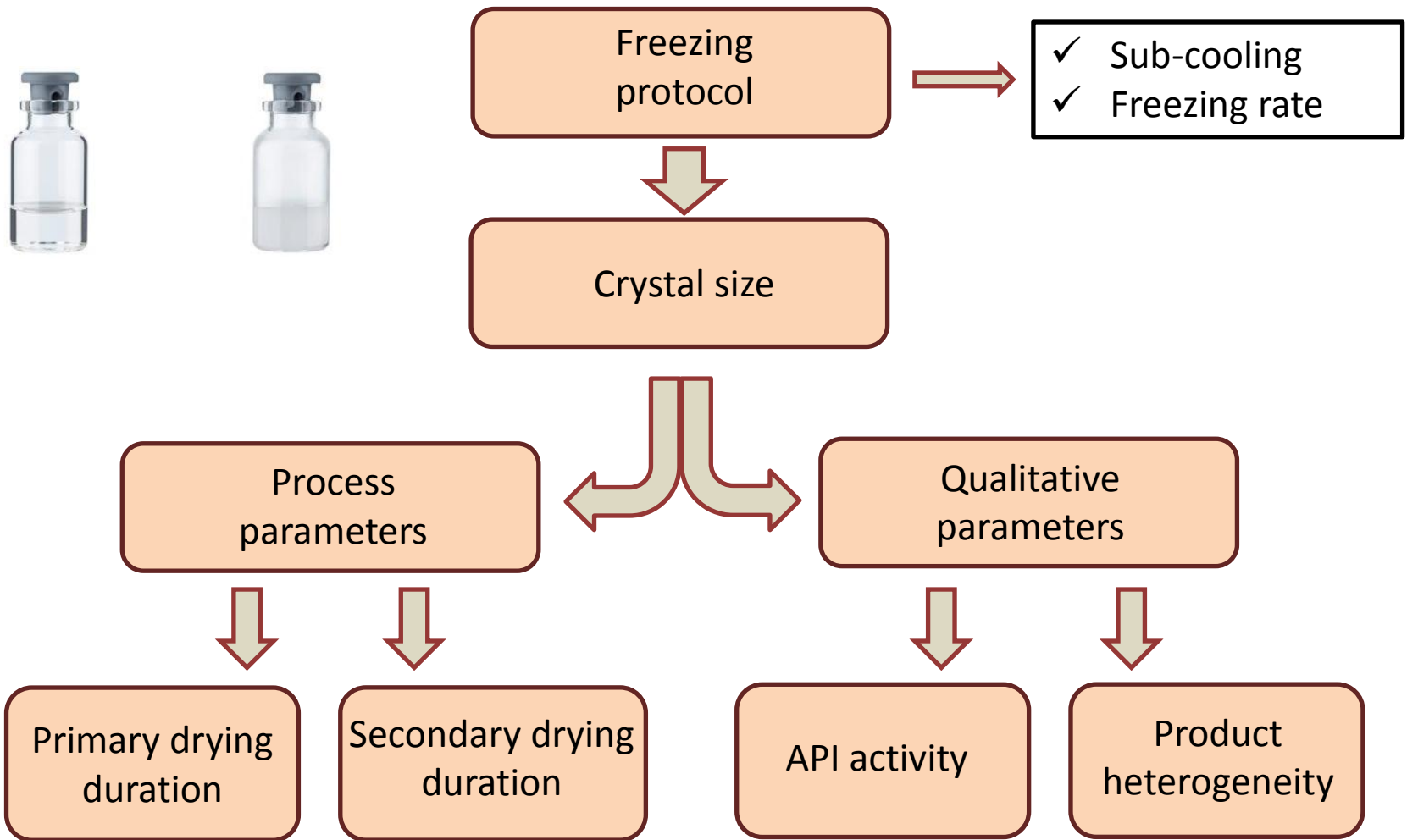

# $R_p$ is influenced by the freezing step

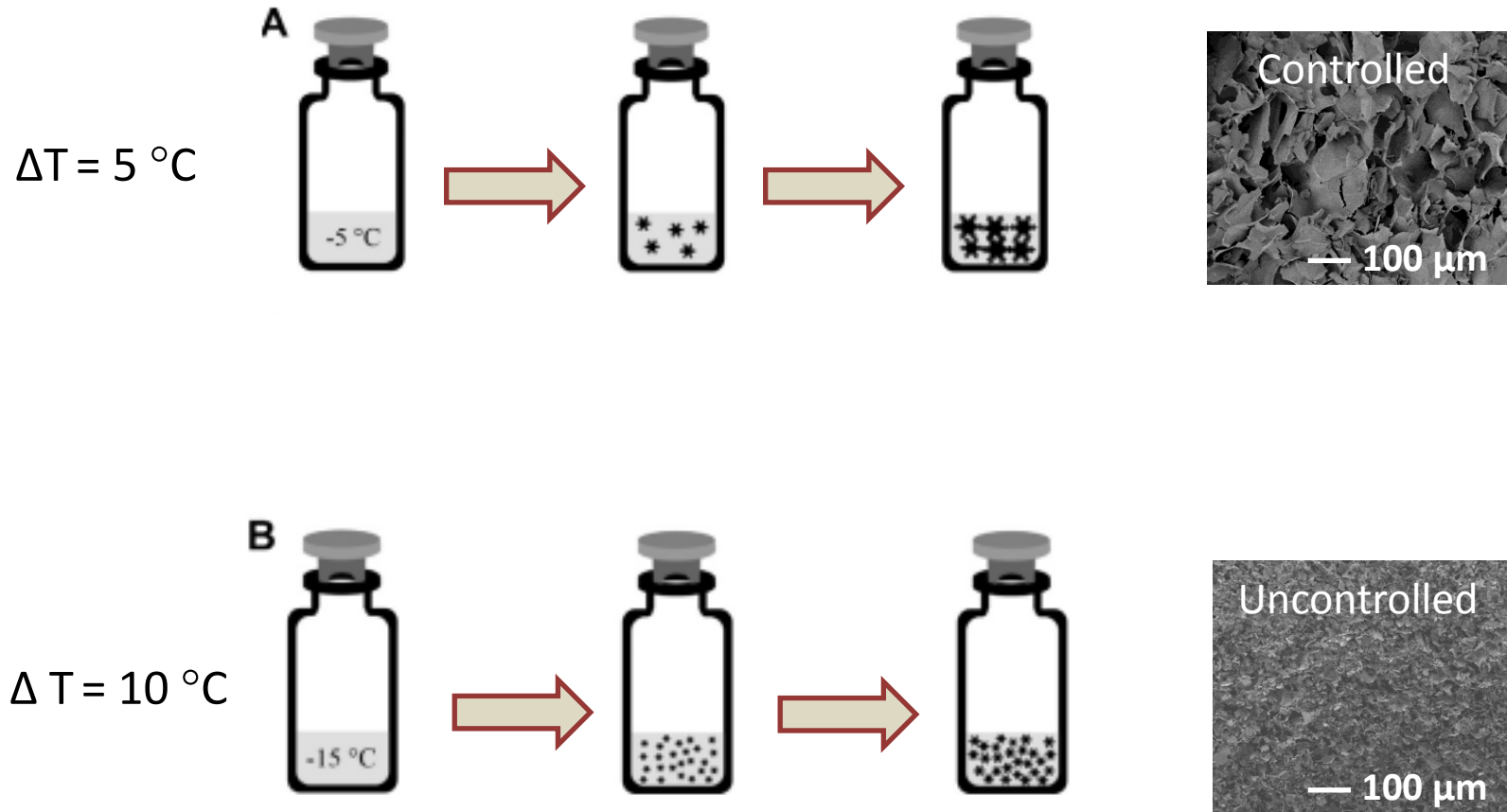



# Freezing protocols

## Uncontrolled nucleation Shelf Ramped Freezing

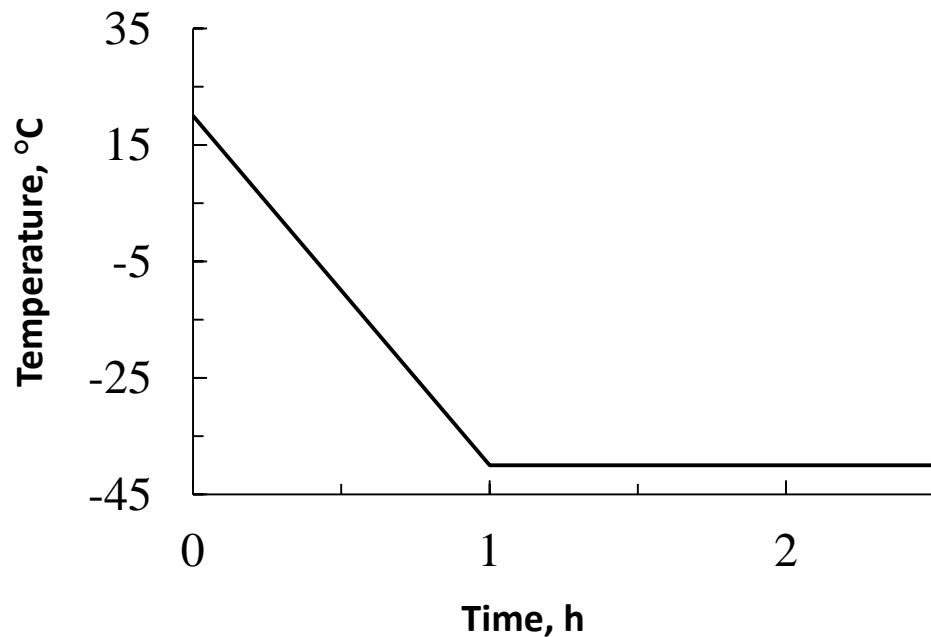

## Controlled nucleation Vacuum Induced Surface Freezing [1]

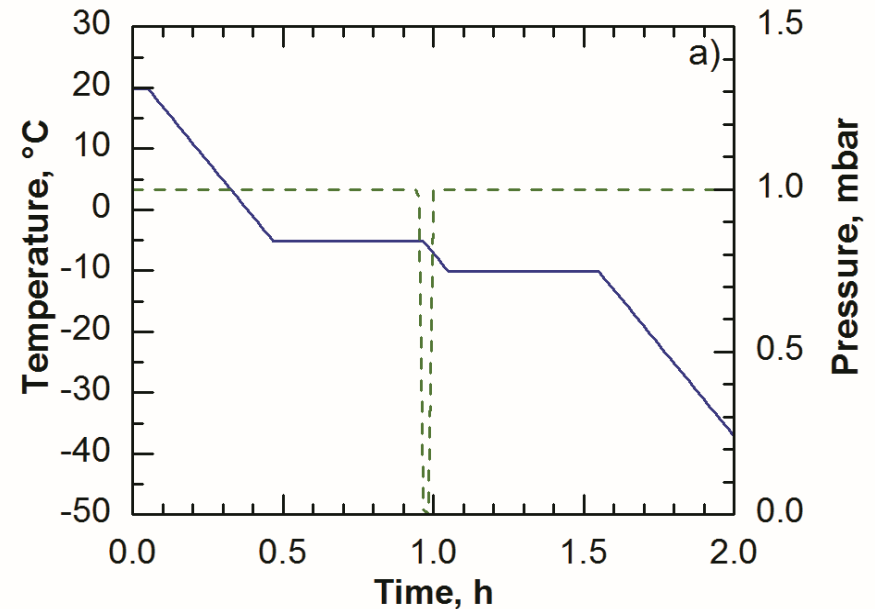

[1] Oddone, I., Pisano, R., Bullich, R., Stewart, P. Vacuum Induced nucleation as a method for freeze-drying cycle optimisation. *Ind Eng Chem Res* 53(47):18236–18244.

# Mathematical modeling of the freezing process

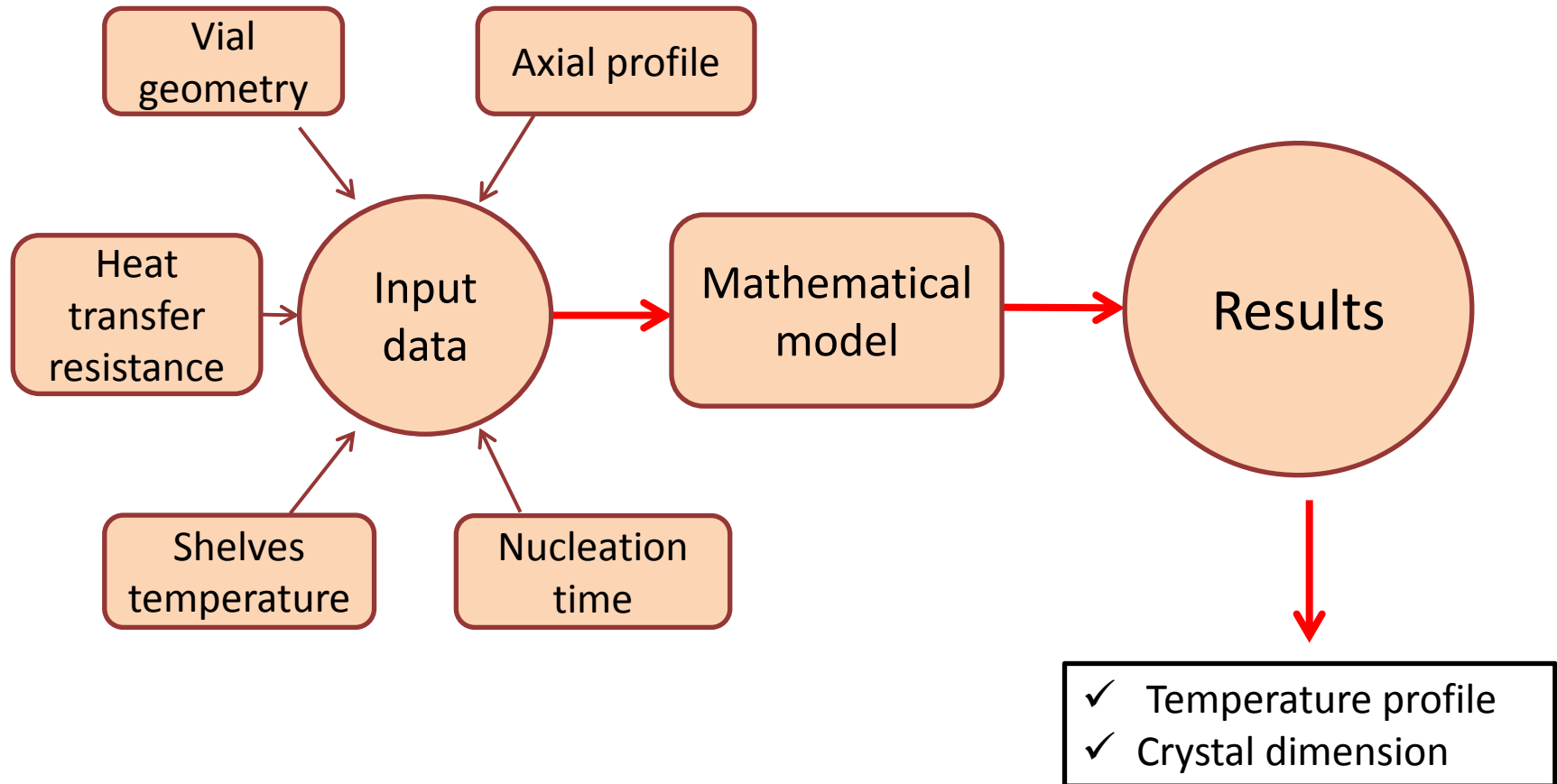

# Mathematical modeling of the freezing process

## Shelf-ramped freezing

Sub-cooling :

$$\rho C_p \frac{\partial T}{\partial t} = \nabla \cdot (k \nabla T)$$

Freezing:

$$\rho C_p \frac{\partial T}{\partial t} = \nabla \cdot (k \nabla T) + Q_n + Q_c$$

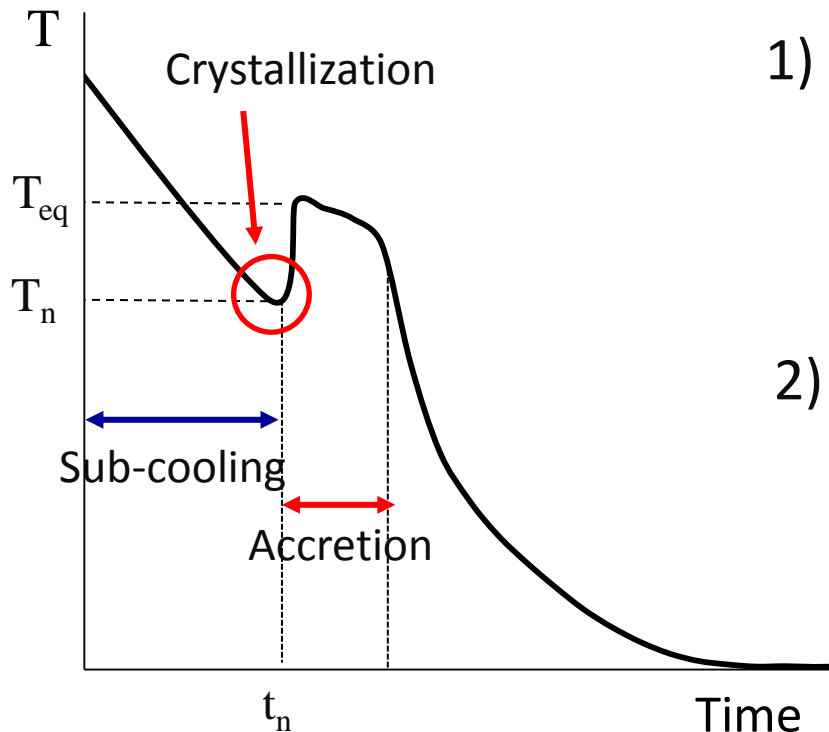

- 1) Heat generation for crystals formation:

$$Q_n = \Delta H_f k_n (T - T_{eq})$$

- 2) Heat generation for crystal accretion:

$$Q_c = \Delta H_f \frac{\partial}{\partial t} (\rho X_{ice})$$

# Mathematical modeling of the freezing process

## Vacuum-induced surface freezing

Pressure decrease:

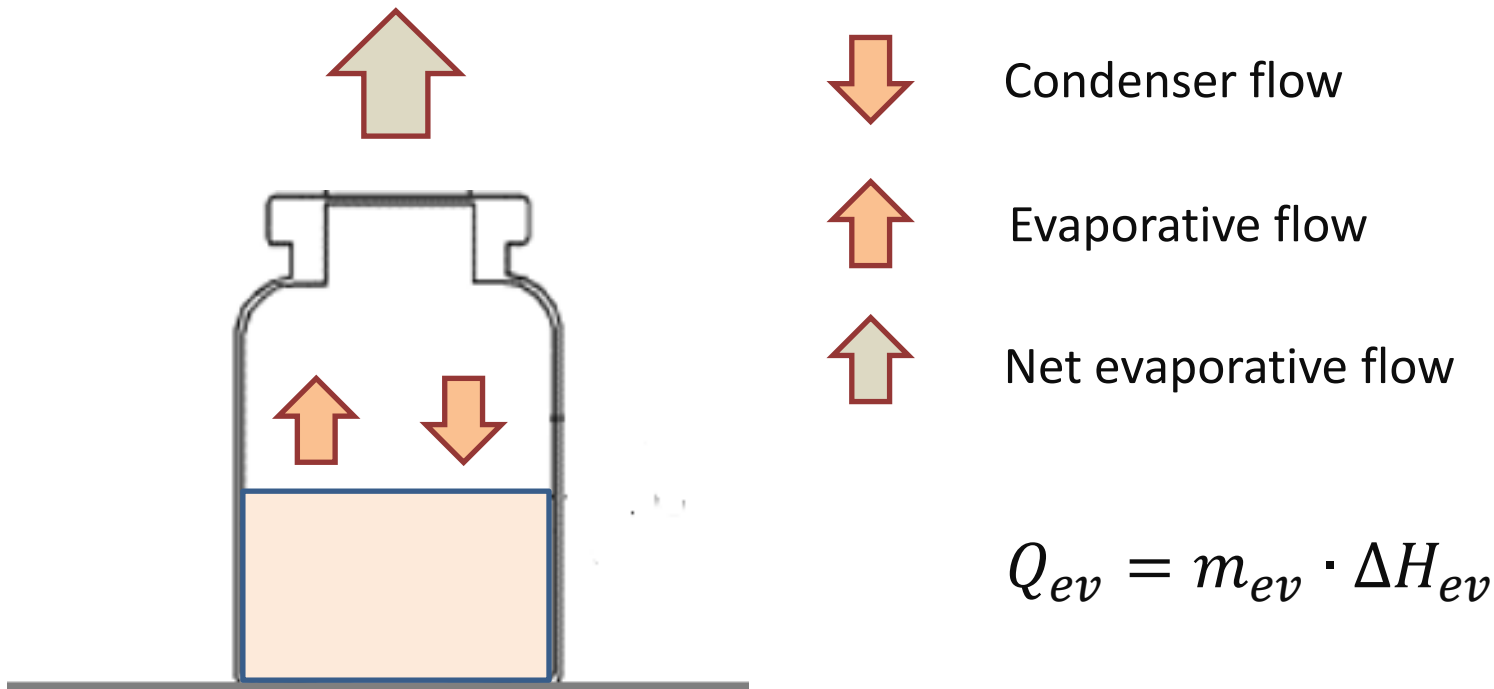

# Model validation

## Shelf-ramped freezing

Evolution of temperature profile

Test 1	
Formulation	Mannitol 5%

Freezing protocol	
Ramp	1.4 °C min <sup>-1</sup>

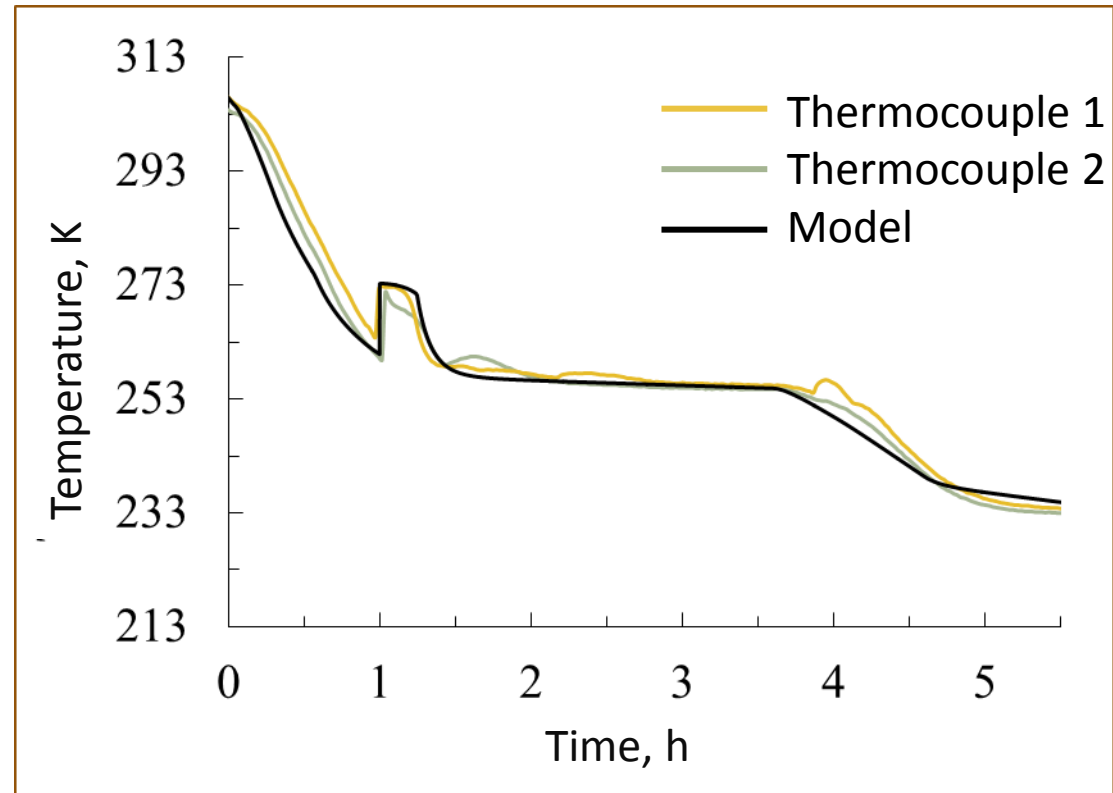

# Model validation

## Crystals dimension

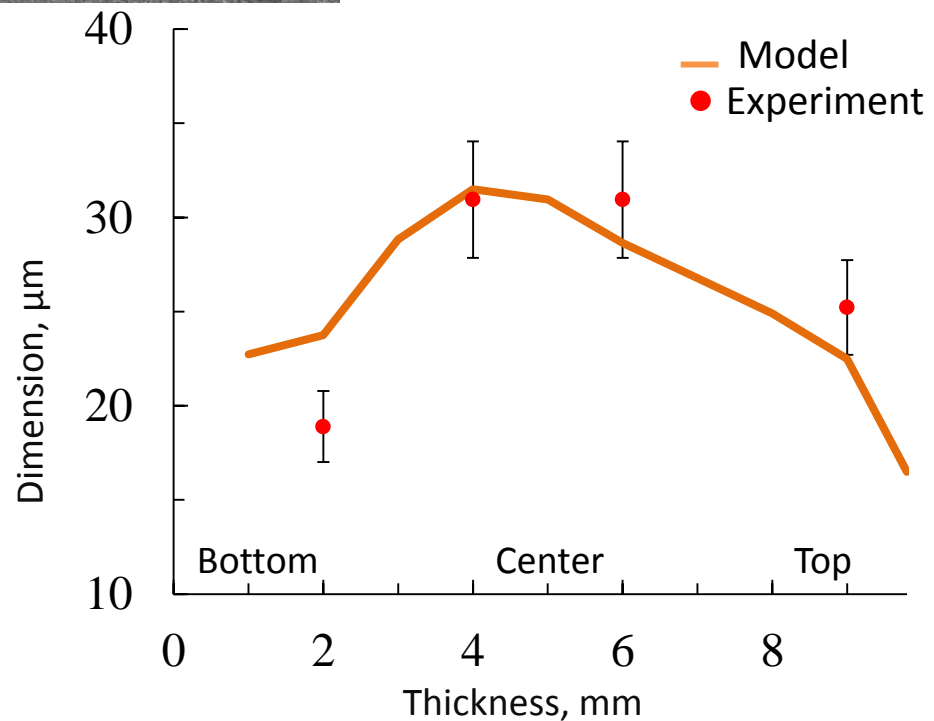
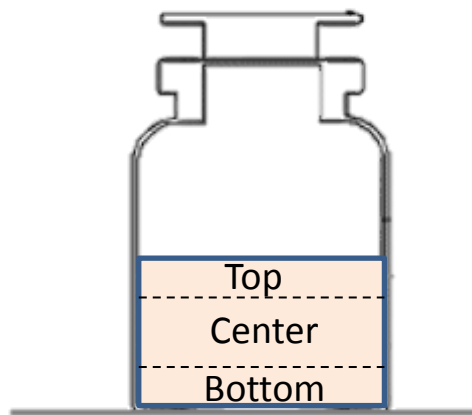
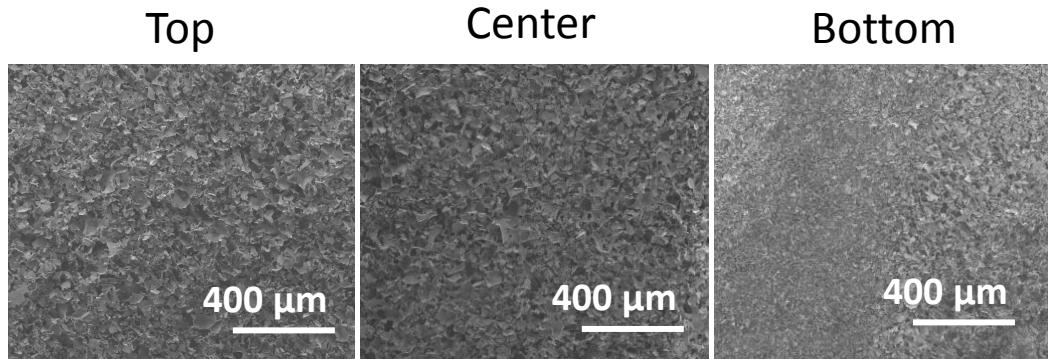

# Model validation

## Vacuum-induced surface freezing

Evolution of temperature profile

Test 5	
Formulation	Mannito 5%

Freezing protocol	
$T_n$	-5 °C
P	130 Pa

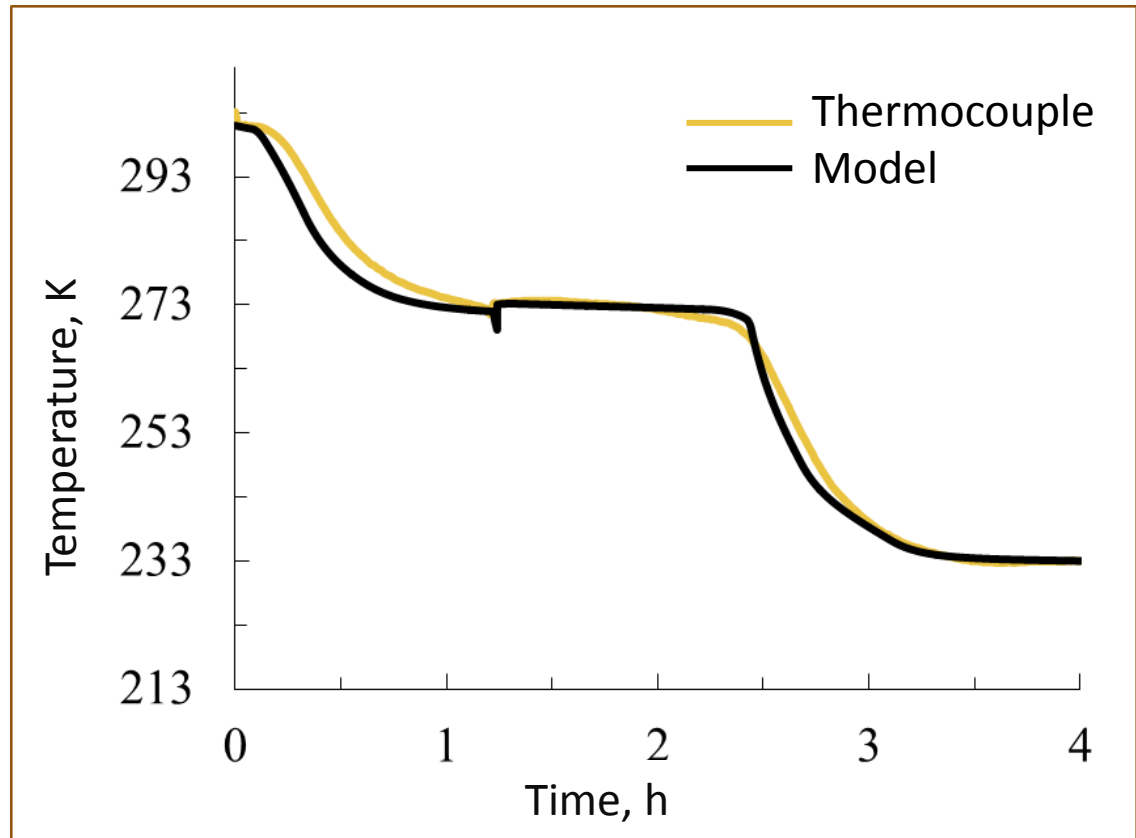

# Model validation

## Crystal dimension

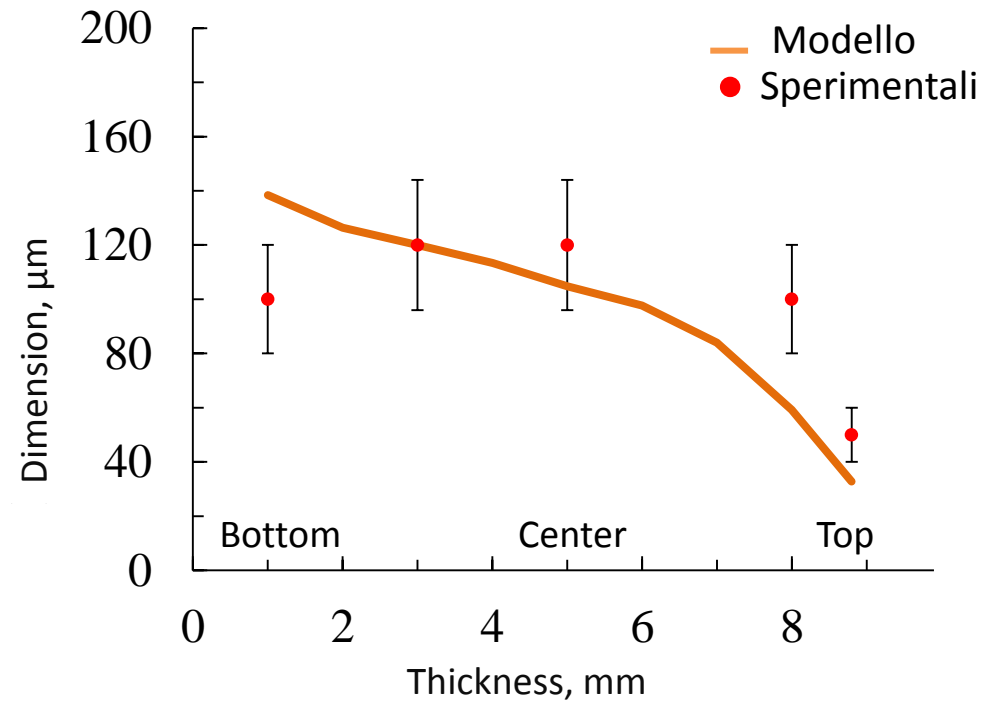
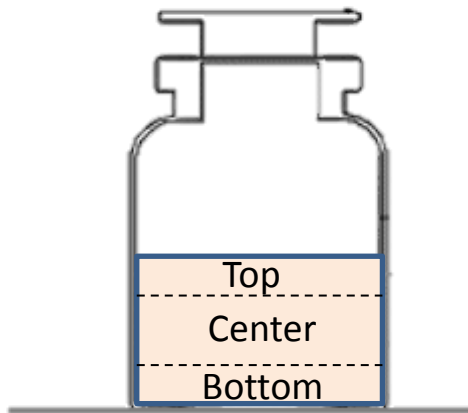
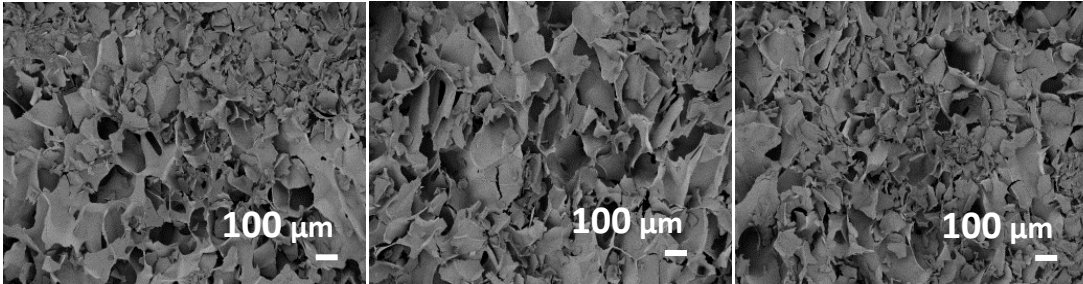



# Model validation

## Influence of freezing on drying time

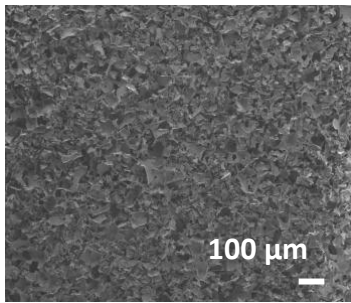

Shelf-ramped

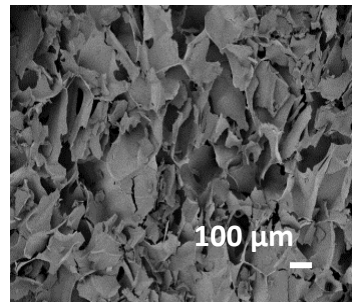

Vacuum-induced surface

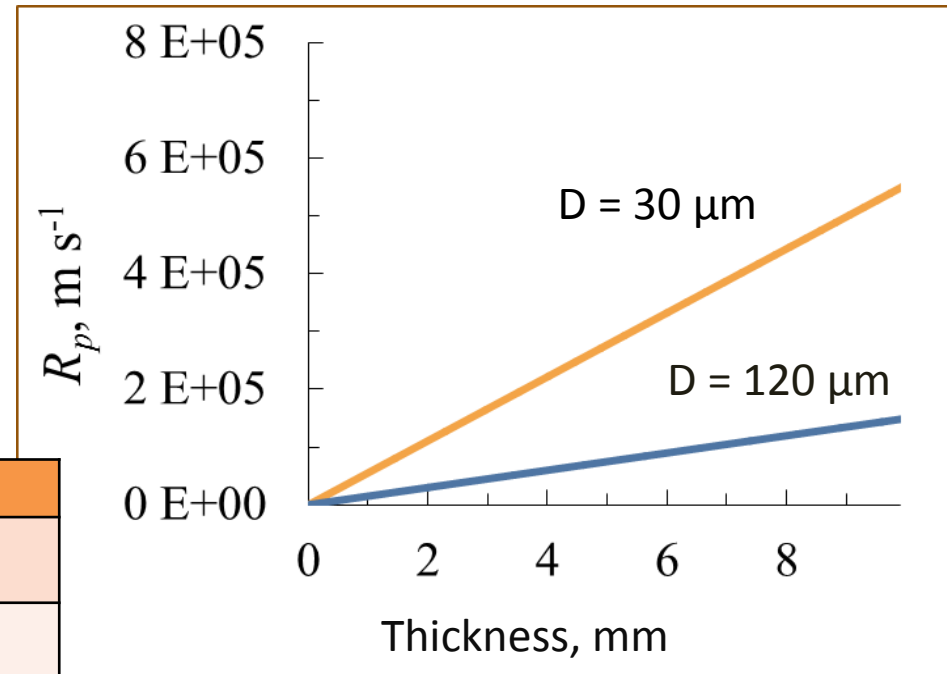

Test	Freezing	Drying time
1	Shelf-ramped	23.3 h
5	Vacuum-induced surface	8.75 h

# An example of model outcomes

## Prediction of the product temperature

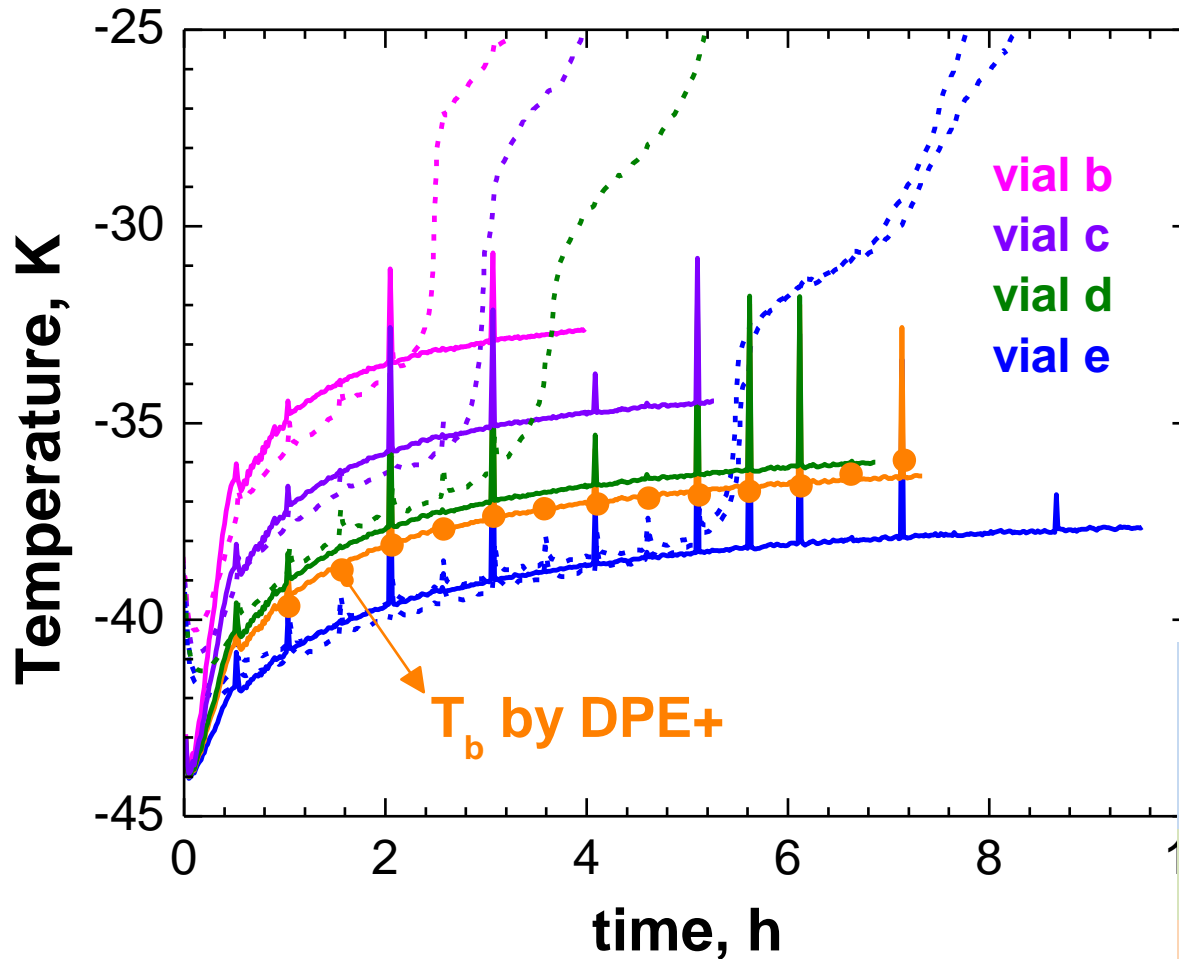

(solid line) model  
(dashed line) exp.

e	e	d	c
e	e	d	b
d	d	d	c
b	b	b	a

# An example of model outcomes

## Prediction of the drying time

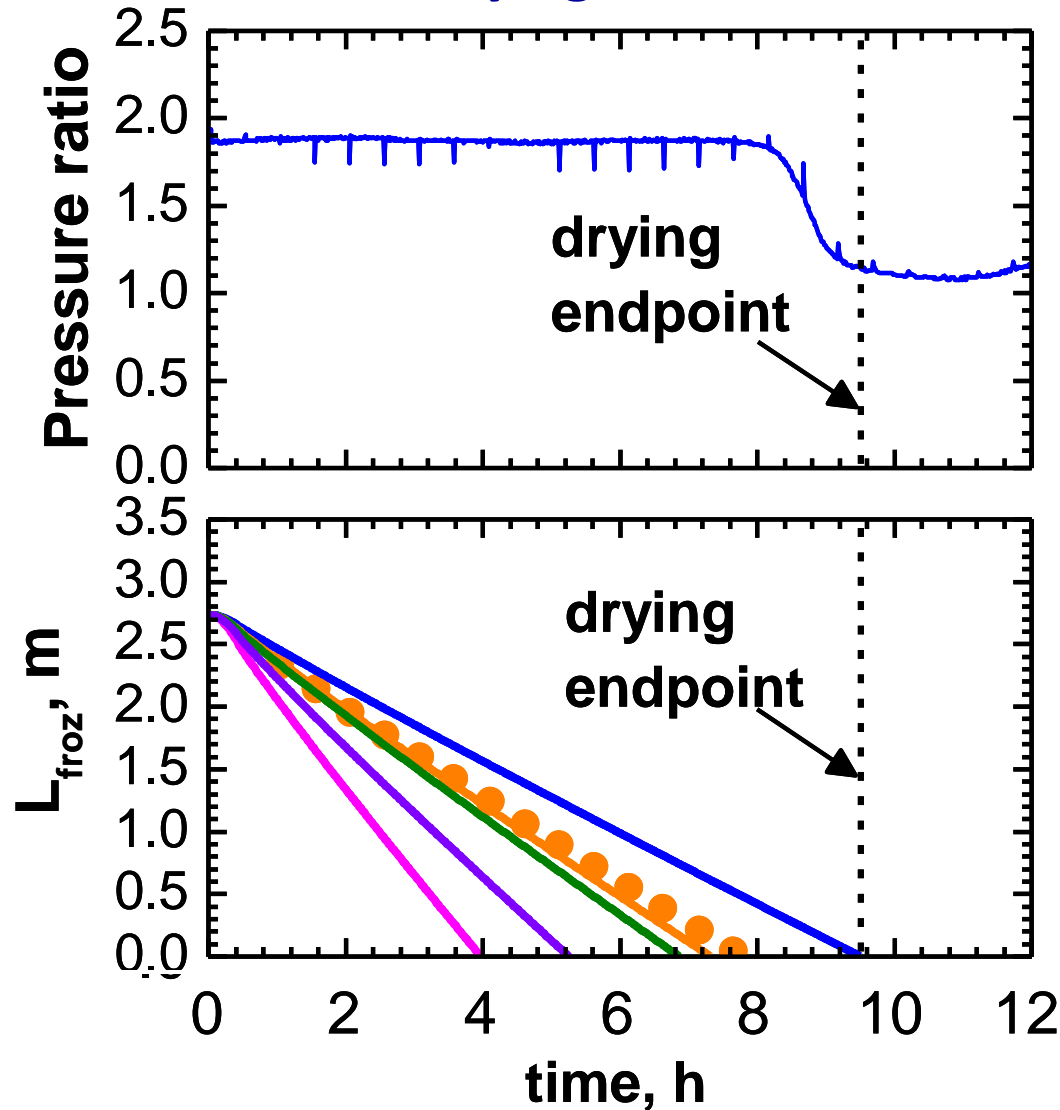

(solid line) model  
(dashed line) exp.

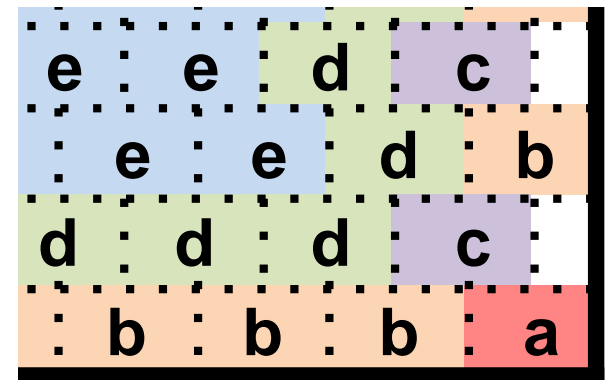

# Off-line methods for cycle development

Off-line methods use mathematical modeling to know in advance which conditions fail to achieve the target.

## Design Space

The design space is a multi-dimensional map showing the combination of processing conditions (temperature of the heat transfer fluid, pressure, and drying progress) and process parameters which provide assurance of quality (critical temperature of the product to be dried).

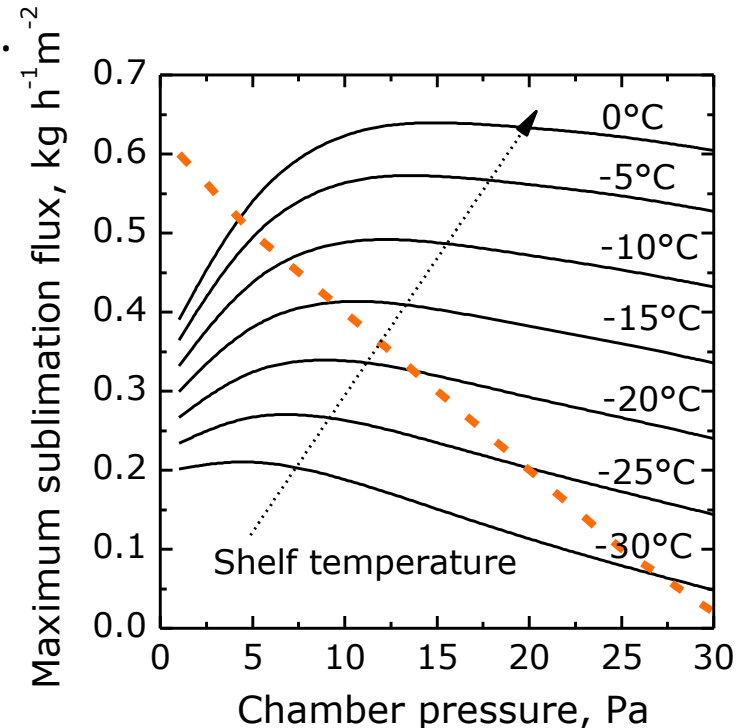
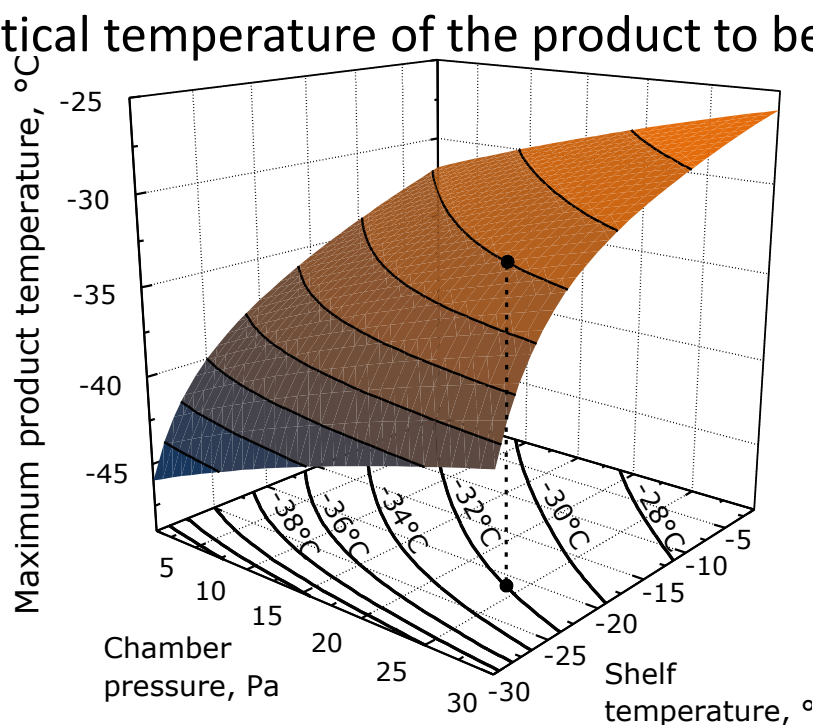

# Off-line methods for cycle development

## Design Space

The drying behaviour is heterogeneous in a batch of vials as the mechanisms involved in the shelf-to-vial heat transfer vary with the position of the vial on the shelf.

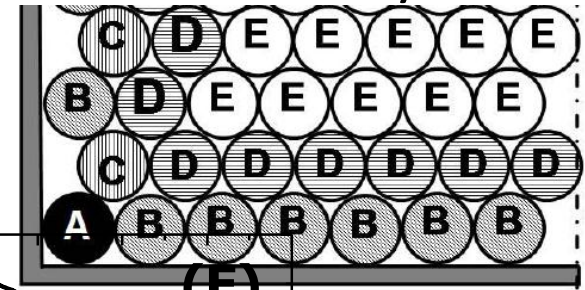
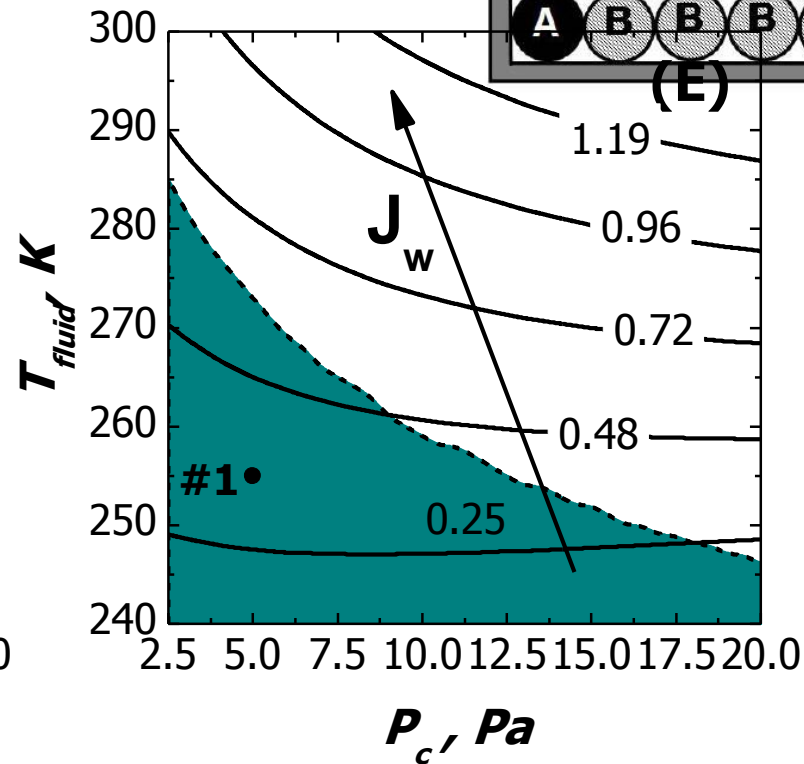
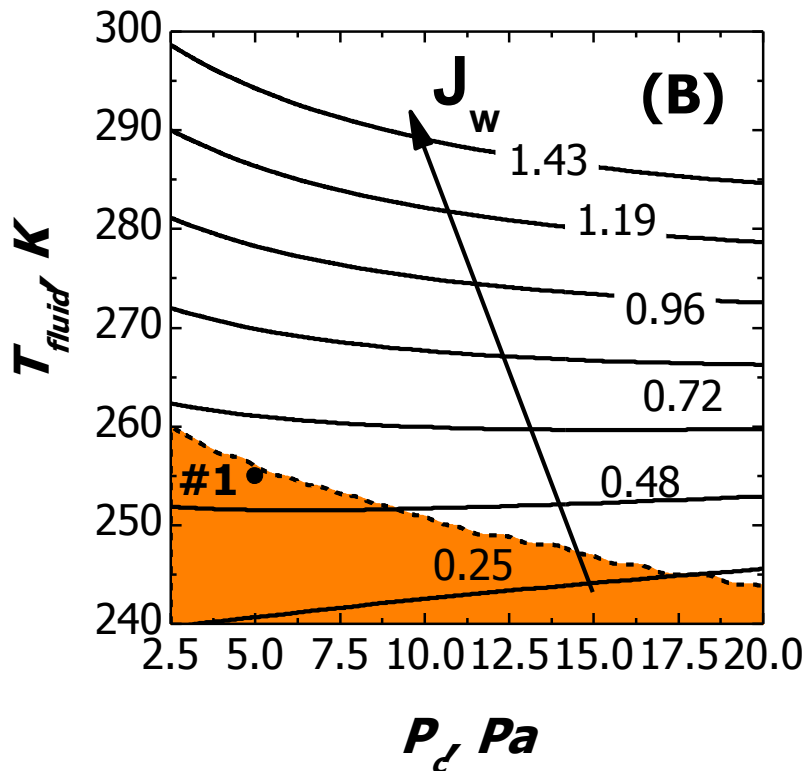

# Off-line methods for cycle development

## Design Space

The drying behaviour is heterogeneous in a batch of vials as the mechanisms involved in the shelf-to-vial heat transfer vary with the position of the vial on the shelf.

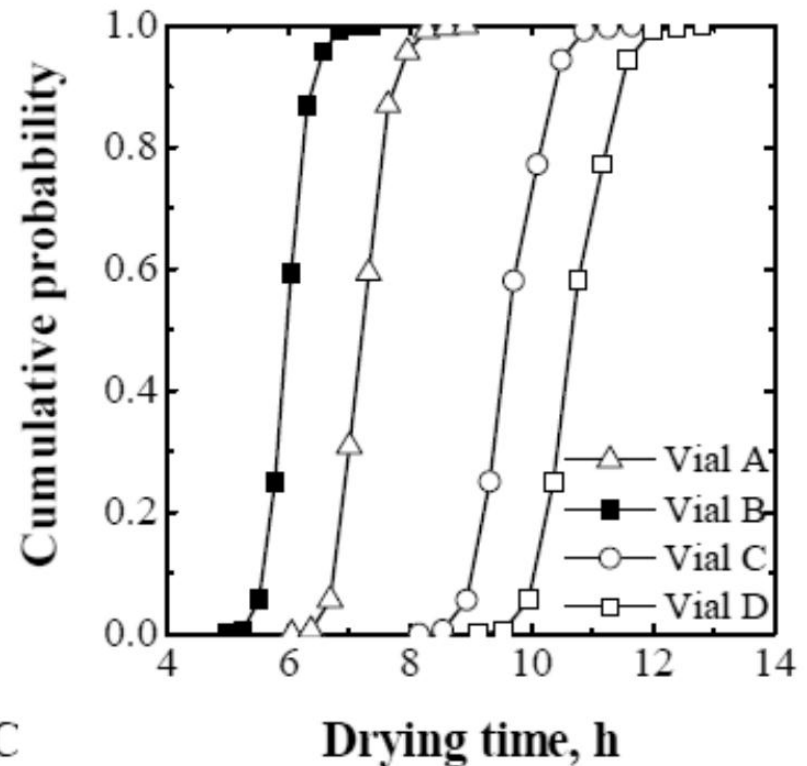
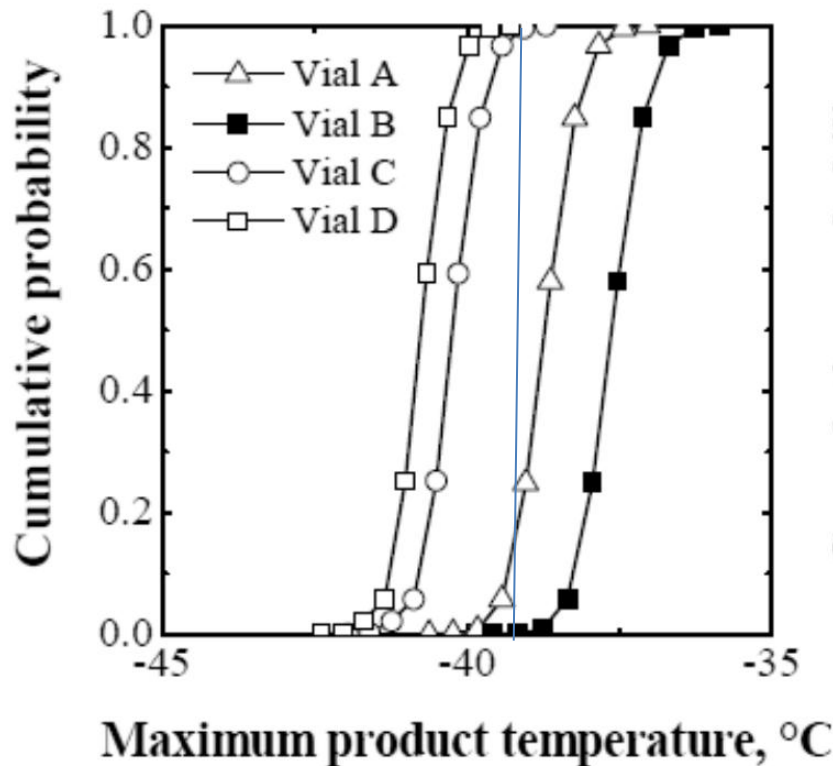

# Off-line methods for cycle development

## Design Space

The drying behaviour is heterogeneous in a batch of vials as the mechanisms involved in the shelf-to-vial heat transfer vary with the position of the vial on the shelf.

### Uncontrolled nucleation Shelf Ramped Freezing

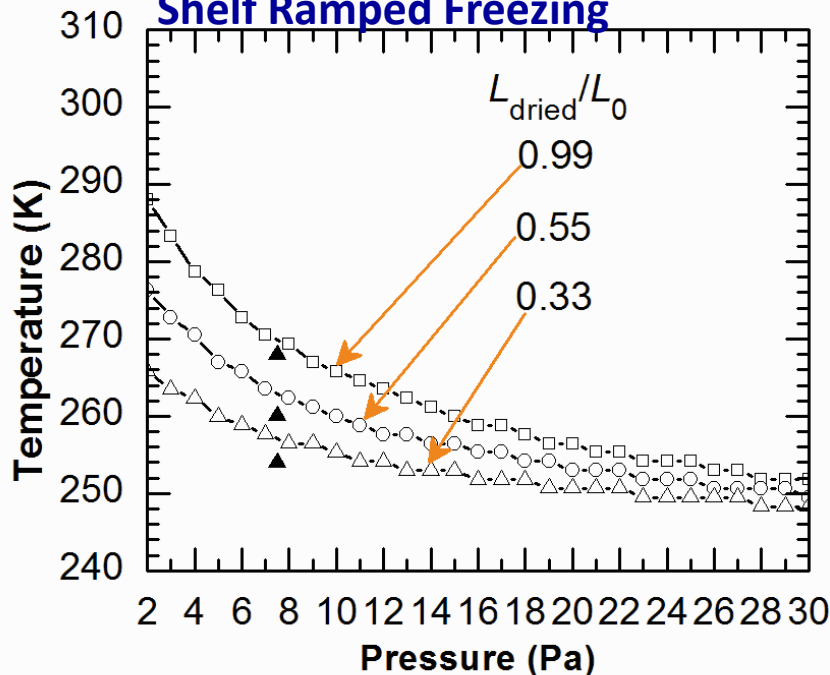

### Controlled nucleation Vacuum Induced Surface Freezing [1]

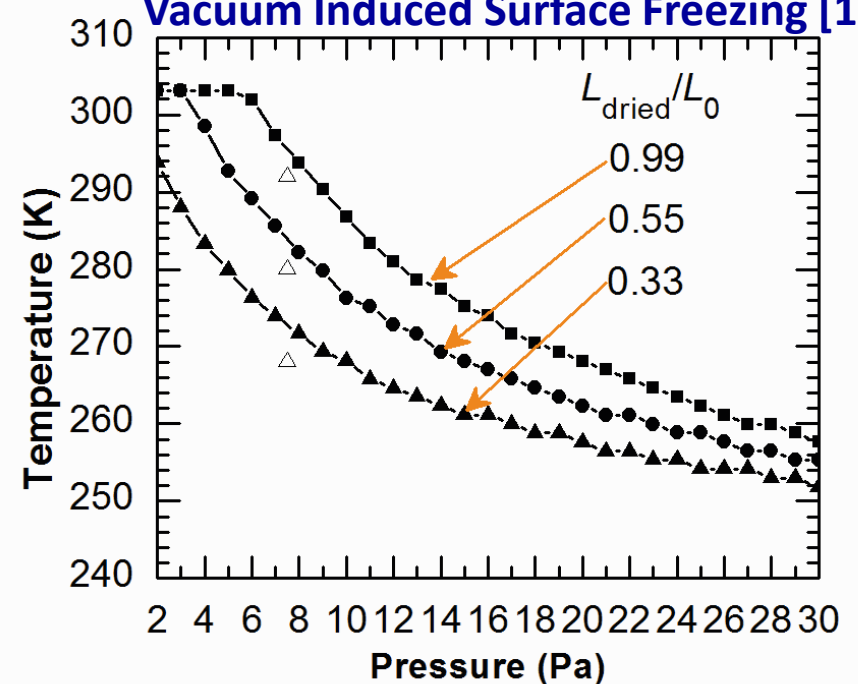

[1] Oddone, I., Pisano, R., Bullich, R., Stewart, P. Vacuum Induced nucleation as a method for freeze-drying cycle optimisation. *Ind Eng Chem Res* 53(47):18236–18244.

# Conclusions

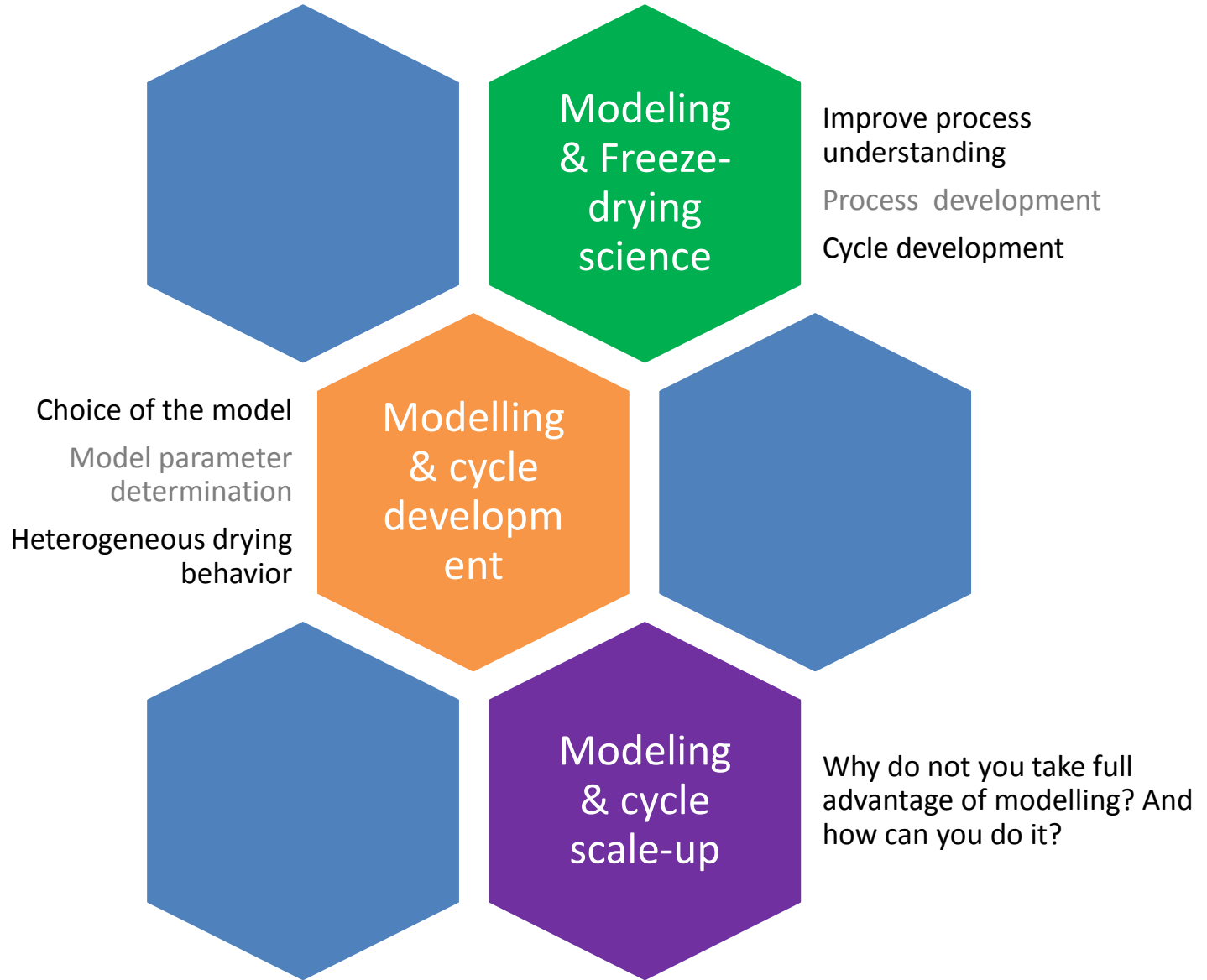



# Thank you for your kind attention

**Contacts:**

**roberto.pisano@polito.it**

**irene.oddone@polito.it**

